

# OPERATING INSTRUCTIONS

## Mechanical Sand Equivalent Shaker

### 24-4945

<p><b>ELE International</b> Chartmoor Road, Chartwell Business Park Leighton Buzzard, Bedfordshire, LU7 4WG England phone: +44 (0) 1525 249200 fax: +44 (0) 1525 249249 email: <a href="mailto:ele@eleint.co.uk">ele@eleint.co.uk</a> <a href="http://www.ele.com">http://www.ele.com</a> ELE International, a division of Hach Lange Ltd</p>	<p><b>Distributor:</b></p>	<p><b>ELE International</b> Soiltest Product Division PO Box 389, Loveland, CO 80539 USA phone: +1 (800) 323 1242 fax: +1 (970) 663 9781 email: <a href="mailto:soiltest@eleusa.com">soiltest@eleusa.com</a> <a href="http://www.eleusa.com">http://www.eleusa.com</a></p>
<p><i>In the interests of improving and updating its equipment, ELE reserves the right to alter specifications to equipment at any time</i> <b>ELE International 2012 ©</b></p>		



## Contents

	<b>Section</b>	<b>Page</b>
1	<b>General Information</b>	<b>3</b>
2	<b>Safety</b>	<b>4</b>
3	<b>Installation</b>	<b>6</b>
4	<b>Dimensions and Mass</b>	<b>8</b>
5	<b>Operator Interface</b>	<b>8</b>
6	<b>Use</b>	<b>10</b>
7	<b>Maintenance</b>	<b>13</b>
8	<b>Diagnosis</b>	<b>14</b>
9	<b>Inactivity</b>	<b>14</b>
10	<b>Decommissioning the Machine</b>	<b>14</b>
	<b>WEEE Directive</b>	<b>15</b>

## 1 General Information

### 1.1 General Features

- Please read this operating instruction carefully because it informs you about the operation of the machine in safety conditions.
- This manual has to be considered part of the product and relates only to the machine it is delivered with.
- Keep the manual in order during the whole life of the appliance to consult it for any needs.
- ELE International assumes no liability for any damage caused by misuse of the machine.
- ELE International reserves the right to modify this technical literature as well as the machine it refers to without any prior notice.
- Messages meaning:

	<b>WARNING</b>	Shows the procedures that can seriously damage the machine if they are not followed carefully.
	<b>DANGER</b>	Shows the procedures that can be dangerous to the operator if they are not followed carefully.

### 1.2 Identification

Machine Identification: See the plate on the machine for complete identification data as well as electrical features.

- 1.3 The Mechanical Sand Equivalent Shaker has been projected to determine the relevant proportions of clay-like or plastic fines and dust in granular soils and fine aggregates. The test is carried out by means of measuring cylinders containing the samples to be determined. It is recommended that only cylinders specially manufactured to meet the standards referred to this kind of test are used.

	<b>WARNING</b>	The instructions given in this operating manual are only made for the correct use of the appliance. To carry out the test in the correct way, the user must refer to the specific standards in force for the test itself.
---	----------------	---

### 1.4 Structure and operation of the machine

The appliance is mainly formed by a device to hold the cylinders (A3). This is equipped with 4 fixing rods and rubber stoppers that secure the cylinders containing the solution.

Inside the frame a motor allows the device and the cylinder (A4) to be shaken with a constant oscillation.

The frame also contains an electric circuit with a timer that automatically stops the appliance at the end of the test (test time is fixed by the testing standards).

The appliance can be supplied with a safety cover, which prevents the operator from touching any of the appliance's moving parts (in accordance with the safety measures foreseen for EEC countries).



EL24-4945/01 Mechanical Sand Equivalent Shaker

Do not hesitate to contact ELE International for any further information.

## 2 Safety

### 2.1 General safety standards

- **The use, lifting, installation, maintenance and scrapping of the machine must only be carried out by fully trained and qualified staff.**  
The user must be carefully taught about the operation of the machine to avoid any misuse of it and about the safety devices, which the machine could be equipped with. The safety devices must always be kept assembled and checked daily.  
ELE International offer training and assumes no liability for any damage due to misuse of the machine by unskilled staff.
- ELE International recommends following carefully the instructions and procedures of the operating manual and the safety standards concerning the safety devices and the general rules of the work environment.
- Verify the accordance of the machine to the standards in force where the machine is to be installed.
- The operating manual must be carefully read by the operators and maintenance engineers. It must always be kept near the machine in order to be able to read it whenever necessary.
- ELE International will not accept responsibility for any unauthorised modifications made to the machine (electrical, mechanical, etc.) without their permission in writing, or for any subsequent damage caused.
- The removal or tampering of the safety devices will be an infringement of the EEC Safety Standards, and ELE International assumes no liability for any subsequent damage caused.
- The machine must be installed away from fire and explosions.
- ELE International recommends using only original spare parts and accessories.
- Should the shaker not be working properly, stop work immediately and contact ELE's service department.

ELE International assumes no liability for any damage caused by the non-compliance of the above instructions.

### 2.2 Safety guards

MEANING: Safety devices are all the safety measures which consist of the use of specific technical equipment (guards, cages etc.) to protect the operator from any danger.

	<b>DANGER</b>	The removal of the safety devices or any tampering of the machine could cause risks to the operator and other people. ELE International assumes no liability for any damage caused due to the tampering of the safety devices.
---	---------------	---

### PASSIVE SAFETY DEVICES

Passive safety devices are those devices which avoid or reduce the risks to the operators. These devices don't require any intervention to be operated.

The Mechanical Shaker, supplied with safety guards, has a protection micro switch that stops the machine functioning whenever the carter is not closed correctly or if it is opened during the test.

### ACTIVE SAFETY DEVICE

Active safety devices are intended to avoid or reduce the risks to the operator. These devices require active intervention to be operated.

The appliance is equipped with a Main Switch (A1) which also acts as a safety switch. By activating it the power supply to the shaker is interrupted and therefore the appliance stops.

### 2.3 Dangerous parts and residual risk

During some procedures the operator could face some risks of danger. The risks can be eliminated by following the procedures in this manual and by using suitable safety devices.

	<b>WARNING</b>	If the machine installation is not carried out by ELE International, employ only skilled operators specifically trained for the lifting of heavy machinery.
---	----------------	---

### GENERAL INFORMATION

- **Before using the equipment, ensure that all the components are in good working condition, and check there are no defective or damaged parts. If necessary repair or replace any damaged parts.**
- Pay attention to the risk of electric shocks either directly or indirectly, due to a failure of the electrical system.
- Do not subject the appliance to impacts or shocks.
- Do not expose the appliance to fire, extreme temperatures or weld splatter.
- Avoid corrosive substances coming into contact with the appliance.
- Do not wash the machine using water spray.

### DURING USE

- **For maximum security for the operator, do not touch any moving parts of the appliance during test execution and wear the correct protection devices.**
- Do not wear large clothes, ties, watches, or anything else which could become entangled in the machine's moving parts.
- If the appliance is not equipped with safety guards, do not stand nearby during the test. This will avoid any incidental contact with the cylinder.
- If the appliance is provided with safety guards, pay attention to the risk of finger crushing when closing them.

## DURING LIFTING

- During lifting, ensure that the machine is securely held and cannot slide.
- Do not stand in a direct line with the application of force.

RISK OR DANGER	PROTECTION DEVICE
FINGER OR ARM CRUSHING	REINFORCED GLOVES
ABRASIONS OR CUTS	REINFORCED GLOVES

ELE International assumes no liability for any damage to people and things due to a lack of observance of the instructions and the use of the safety devices.

### 2.4 Noise

The indicated levels of noise are not necessarily safety levels for the operator. The exposure levels to the operator are obviously related to the emission levels of the appliance, but other factors influence the exposure levels at the time of exposure; the environment, other appliances installed near to the appliance, etc. The exposure levels show the damage that could be caused by the noise.

Acoustic pressure level equivalent <b>L<sub>aeq</sub></b> , in the working place	<b>83</b> dB(A)
Acoustic power emitted by the appliance <b>L<sub>WA</sub></b>	<b>98</b> dB(A)
Relevant Standard	<b>EN ISO 3746</b>

	<b>DANGER</b>	<p>The continuous use of the machine, together with other noisy appliances, could cause a high level of exposure. If the daily exposure to the operator is equal or higher than 85 dB(A), safety devices such as headphones should be worn.</p> <p>If the daily exposure is equal or higher than 90 dB(A), the use of the safety device is <b>compulsory</b>.</p> <p>For further information, consult the standards of the country where the machine has been installed.</p>
---	---------------	--

## 3 Installation

	<b>DANGER</b>	<p>Consult <b>DANGEROUS PARTS AND RESIDUAL RISKS</b> before proceeding.</p>
---	---------------	---

### 3.1 Lifting

The operating instructions must be respected during:

- Lifting and storing
- The first installation
- Further installations

The machine is usually packed in a wooden case to be moved by forklift. During the lifting of the case, the utmost care must be taken to follow the lifting directions labelled on the case. If possible, use a forklift or crane and fasten the case with belts and ropes, avoiding the use of chains.

	<b>DANGER</b>	Pay attention to avoid impacts and turnovers.
---	---------------	---

	<b>DANGER</b>	Protect the machine from atmospheric agents. Water and humidity could oxidise it, damaging it seriously.
---	---------------	--

### 3.2 Unpacking

After removing the packaging, check that no parts of the machine are damaged. In case of doubt, **DO NOT USE THE MACHINE**, and contact ELE International.

	<b>DANGER</b>	The materials used for packaging (plastic, polystyrene, screws, nails, wood etc.) must be kept away from children. They must be disposed of appropriately.
---	---------------	--

	<b>WARNING</b>	Pay attention to avoid impacts and turnovers.
---	----------------	---

	<b>WARNING</b>	Before disposing of the packaging, please check that any accessories, manuals, documents, spare parts are not inside.
---	----------------	---

### 3.3 Installation

The machine must be placed in a environment suitable for its use (ie laboratory). Installation must be carried out by a skilled operator.

<b>ALLOWED TEMPERATURE</b>	from + 5°C to + 40°C
<b>ALLOWED HUMIDITY</b>	from 30% to 95%
<b>O.S.L. MAX. HEIGHT</b>	1000 m

#### GENERAL WARNINGS

- The machine must be installed so that it has space either side to allow easy maintenance.
- No unauthorised people or dangerous objects must be allowed near the appliance.

### 3.4 Electrical connections

	<b>DANGER</b>	<p>Skilled operators must arrange the electrical connections. Before connecting, see the attached electrical diagram and the plate on the machine for the information relating to the voltage and frequency, etc.</p> <p>Connect the ground by the terminal PE (yellow-green) before making any other connections.</p> <p>Apply a knife switch at the top of the connecting cable of the machine to the power system.</p> <p>The knife switch must be combined with a safety device against the overload with a differential switch (safety switch).</p> <p>The technical features of the safety device must be in accordance with the standards in force in the country where the machine has been installed.</p>
---	---------------	--

## ELECTRIC TOLERANCES:

- Real voltage:  $\pm 10\%$  of the nominal.
- Frequency :  $\pm 1\%$  of the nominal in a continuous way,  
 $\pm 2\%$  of the nominal for a short period.
- The harmonic distortion of the sum from the second to the fifth harmonics not more than 10% of the total voltage as a real value between the conductors. A further distortion of 2% is accepted for the sum from the sixth to the thirtieth harmonics of the real total value between the conductors.
- With reference to the tension unbalance of the three-phase voltage, the inverted sequence component and the zero sequence component must not be more than 2% of the direct sequence component of the voltage.
- The voltage pulses must not last more than 1,5 ms with an up/down time between 500 ms and 500  $\mu$ s and a peak value not higher than 200% of the real value of the nominal tension.
- The electric feeding must not be interrupted or zeroed for more than 3 ms. Between two interruptions it must not take more than 1 s.
- The interruptions must not overcome 20% of the tension peak for more than one cycle. Between two interruptions it must not take more than 1 s.

## 4 Dimensions and Mass

<b>LENGTH</b>	330 mm
<b>WIDTH</b>	745 mm
<b>HEIGHT</b>	320 mm
<b>MASS</b>	30 kg approx.

## 5 Operator Interface

### 5.1 Commands and symbols

	<b>COMMAND</b>	<b>DESCRIPTION</b>
<b>A1</b>	MASTER SWITCH	Turns the shaker on and off. Also acts as an emergency switch.
<b>A2</b>	TIMER	Sets the test length according to the standard it refers to.
<b>A3</b>	CYLINDER HOLDER	Holds the cylinder containing the solution. The cylinder holder has a lever lock, which locks the cylinder in position.
<b>A4</b>	PULLEY	By varying the distance between the sides, the frequency of cycles per minute can be changed according to the standard being tested to.
<b>A5</b>	ELECTRIC MOTOR	Moves the cylinder holder.
<b>A6</b>	FEET	Allow the shaker to stand firmly on any kind of surface.
<b>A8</b>	FRONT GUARD	Allows access to the internal parts of the appliance.



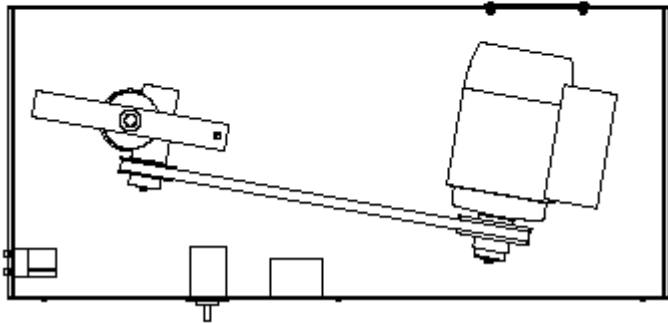
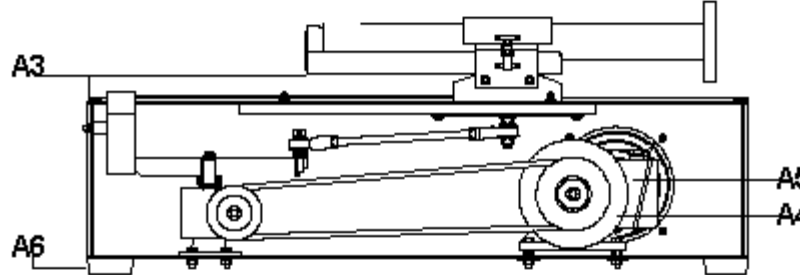
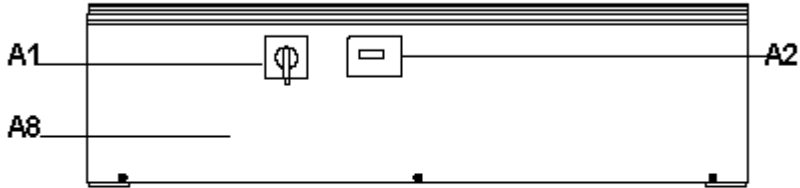

## **6 Use**

### **6.1 Suggestions**

Check the appliance has been installed correctly and that it has been placed in suitable working conditions before use; check its parts are not defective, damaged or worn. Carry out any necessary maintenance operations.

### **6.2 Work place**

All operations must be carried out with the operator in front of the appliance.

### **6.3 Sample positioning**

The sample, together with an appropriate solution, must be connected in the cylinder holder which is positioned horizontally on the A3 cylinder holder. The cylinder holder has a lever lock to hold the cylinder in place.

Before placing the cylinder on the A3 cylinder holder, close the open end of the cylinder with the appropriate rubber plug to prevent the solution from escaping.

### **6.4 Switching on the appliance**

Position the master switch to "I".

### **6.5 Regulation of stirring time**

When the appliance is switched on, the timer displays the figures "00".00".

Press the "sec" key once to set the second timing (keep the key pressed to make the count move forward more quickly).

Press the "min" key once to set the count one minute at a time (keep the key pressed to make the count move forward more quickly).

### **6.6 Regulation of stirring frequency**

The appliance is set in the factory according to the standard requested by the client (EN or ASTM).

If the user would like to follow an International Standard different to the one set, or if a different frequency is required, proceed as follows:

#### **REGULATION OF STIRRING FREQUENCY**

The shaker is equipped with a transmission belt and a pulley with variable diameter applied on the motor. The pulley is equipped with a fixed side and a mobile side which can change the diameter of the actual pulley.

As in the attachment, when the distance between the two sides is 22 mm, the setting for the ASTM test is reached, whilst with the distance of 20.5 mm, the setting for the AFNOR-EN test is reached.

To vary the distance of the sides, proceed as follows:

- Ensure the appliance is connected to the electrical supply network.
- Remove the front guard (A8) by unscrewing the six fixing screws.
- Loosen the fixing screws of the motor positioned on the lower part of the machine, and move the motor to loosen the belt.
- Unscrew all dowels of the mobile side, but without removing it; then rotate it in such a way to vary the winding diameter of the pulley.
- Note: screwing the side, the diameter increases and therefore the number of shakers increases. On the contrary, by unscrewing the side, the diameter and the number of shakers/per minute decreases.
- Fix the mobile side by securing the fixing mechanisms again.
- Make the belt tense (not excessively) by moving the motor in the initial position and securing the fixing screws again.
- Reposition the front guard (A8).
- Proceed with small steps by performing little adjustments and checking the variation of the shaking frequency. If required, perform another adjustment.

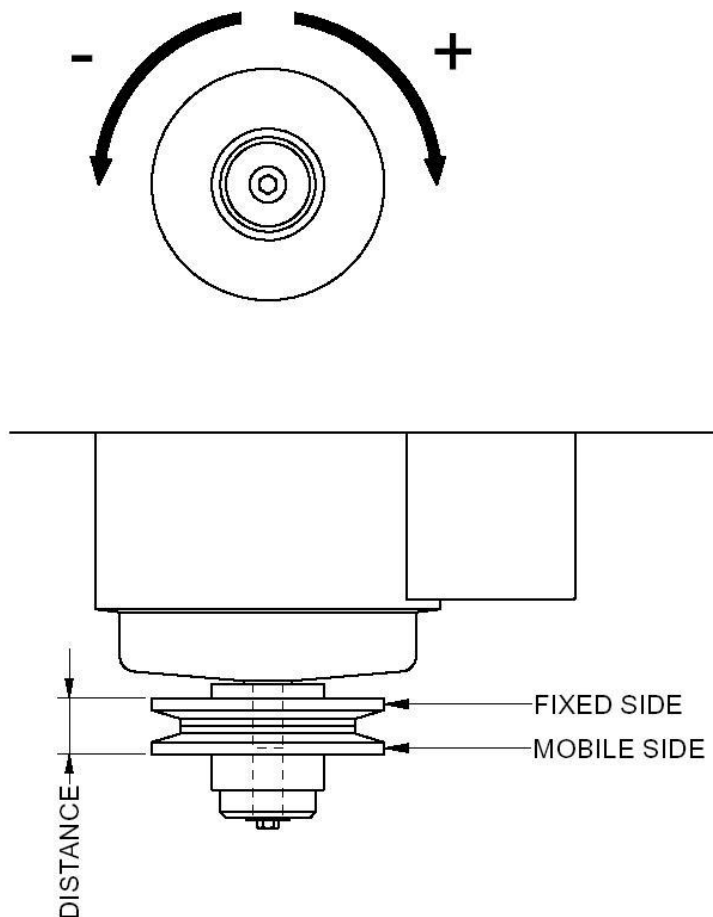

## 6.7 Switching the appliance on

Press the “START/STOP” key on the timer to start the count.  
The LED on the timer and the display updates the time every second.

## 6.8 Normal stop

The appliance stops automatically when the set time has passed. The LED on the timer switches off; an acoustic signal sounds; press any key to stop the ringing; the display will show the previously set time.

<b>N.B.</b>	To stop the test before the end of the count press the “START/STOP” key on the timer.
-------------	---

In this case on the timer the remaining time will be saved.

Before starting a new test, correctly reset the test time. Switch the shaker off with the master switch (A1).

## 6.9 Emergency stop

In case of emergency the test run can be stopped immediately by positioning the master switch (A1) to “0”.

## 6.10 Restart after emergency stop

	<b>DANGER</b>	Before restarting the machine detect and remove the cause of the emergency stop.
---	---------------	--

Simply turn the master switch (A1) to “I” to restart the machine.

## 6.11 Switching off

Position the master switch to “0”.

## 6.12 Test start up

Before using the appliance regularly check it is working correctly by carrying out at least one complete empty cycle according to the previous instructions. Should there be any problems consult the “DIAGNOSTICS” section.

If the instructions in this manual do not provide the solution to the problem, contact ELE International.

## 7 Maintenance

 <p><b>WARNING DANGER</b></p>	<p>Consult <b>DANGEROUS PARTS AND RESIDUAL RISKS</b> <b>before</b> proceeding.</p> <p>All the maintenance operations must be carried out with the machine turned off and unplugged from the knife switch.</p> <p>Any kind of maintenance operations relating to the components of the machine and the electrical components, even those that may seem very simple, must be carried out by skilled operators.</p> <p>Only original spare parts must be used. ELE International assumes no liability in the event that non-original parts are used.</p>
--	---

### 7.1 Standard maintenance

 <p><b>WARNING DANGER</b></p>	<p>Do not perform maintenance on the machine which has not been described in this instruction manual without first contacting ELE International.</p> <p>Periodically clean all machine parts and oil the unpainted parts in order to preserve the machine and its efficiency.</p> <p>Avoid the use of solvents which damage paint and parts of synthetic material.</p>
--	--

### 7.2 Periodic operation

Carry out the periodical operations shown below in order to prevent possible damage or malfunctioning.



OPERATION	TRANSMISSION BELT CHECK
<b>PROCEDURE</b>	Remove the guard with the six fixing screws; turn the screws which fix the motor and move the motor back until the optimum chain tension is obtained. Should the tension be corrected frequently, the belt must be changed.
<b>PRECAUTIONS</b>	Before operation turn the master switch (A1) to "0" and physically disconnect the appliance from the electrical supply.
<b>FREQUENCY</b>	EVERY SIX MONTHS OF USE

### 7.3 Special maintenance

For extraordinary maintenance operations (repairs, substitutions and any other operation not described in this manual), refer directly to ELE International.

## 8 Diagnosis

This chapter introduces and discusses simple problems which could arise when the machine is working.

 	<b>WARNING DANGER</b>	All maintenance procedures on this machine or the electrical system must be carried out by appropriately qualified, professional personnel.
---	---------------------------	---

	POSSIBLE CAUSE	REMEDY
The timer does not turn on after pressing the master switch	No supply	Check the plug has been inserted correctly
	Damaged timer	Contact ELE's service department
The appliance does not work after starting the test	Broken electrical supply	
	Incorrect closure of the safety cover (if supplied)	Close the safety cover
	Broken motor	Contact ELE's service department
	Damaged timer	Contact ELE's service department

## 9 Inactivity

Should the machine be inactive for a long period of time, ensure all machine parts are in safe working order before re-using it. When in doubt contact ELE International.

## 10 Decommissioning the Machine

If the machine is no longer to be used, proceed as follows:

- Disconnect the electrical supply network by removing the connecting cable, thereby making it unusable.
- Make the potential sources of danger harmless, such as sharp or protruding parts.
- Dismantle the machine; divide it into smaller parts and dispose of according to the standards in force.

## DIRECTIVE ON WASTE ELECTRICAL & ELECTRONIC EQUIPMENT (WEEE)

	<p>Electrical equipment marked with this symbol may not be disposed of in European public disposal systems after 12 August of 2005. In conformity with European local and national regulations (EU Directive 2002/96/EC), European electrical equipment users must now return old or end-of life equipment to the Producer for disposal at no charge to the user.</p> <p><b>Note:</b> For return for recycling, please contact the equipment producer or supplier for instructions on how to return end-of-life equipment for proper disposal.</p> <p><b>Important document. Retain with product records.</b></p>
<p><b>GERMAN</b></p> <p>Elektrogeräte, die mit diesem Symbol gekennzeichnet sind, dürfen in Europa nach dem 12. August 2005 nicht mehr über die öffentliche Abfallentsorgung entsorgt werden. In Übereinstimmung mit lokalen und nationalen europäischen Bestimmungen (EU-Richtlinie 2002/96/EC), müssen Benutzer von Elektrogeräten in Europa ab diesem Zeitpunkt alte bzw. zu verschrottende Geräte zur Entsorgung kostenfrei an den Hersteller zurückgeben.</p> <p><b>Hinweis:</b> Bitte wenden Sie sich an den Hersteller bzw. an den Händler, von dem Sie das Gerät bezogen haben, um Informationen zur Rückgabe des Altgeräts zur ordnungsgemäßen Entsorgung zu erhalten.</p> <p><b>Wichtige Informationen. Bitte zusammen mit den Produktinformationen aufbewahren.</b></p>	
<p><b>FRENCH</b></p> <p>A partir du 12 août 2005, il est interdit de mettre au rebut le matériel électrique marqué de ce symbole par les voies habituelles de déchetterie publique. Conformément à la réglementation européenne (directive UE 2002/96/EC), les utilisateurs de matériel électrique en Europe doivent désormais retourner le matériel usé ou périmé au fabricant pour élimination, sans frais pour l'utilisateur.</p> <p><b>Remarque :</b> Veuillez vous adresser au fabricant ou au fournisseur du matériel pour les instructions de retour du matériel usé ou périmé aux fins d'élimination conforme.</p> <p><b>Ce document est important. Conservez-le dans le dossier du produit.</b></p>	
<p><b>ITALIAN</b></p> <p>Le apparecchiature elettriche con apposto questo simbolo non possono essere smaltite nelle discariche pubbliche europee successivamente al 12 agosto 2005. In conformità alle normative europee locali e nazionali (Direttiva UE 2002/96/EC), gli utilizzatori europei di apparecchiature elettriche devono restituire al produttore le apparecchiature vecchie o a fine vita per lo smaltimento senza alcun costo a carico dell'utilizzatore.</p> <p><b>Nota:</b> Per conoscere le modalità di restituzione delle apparecchiature a fine vita da riciclare, contattare il produttore o il fornitore dell'apparecchiatura per un corretto smaltimento.</p> <p><b>Documento importante. Conservare con la documentazione del prodotto.</b></p>	
<p><b>DANISH</b></p> <p>Elektriske apparater, der er mærket med dette symbol, må ikke bortskaffes i europæiske offentlige affaldssystemer efter den 12. august 2005. I henhold til europæiske lokale og nationale regler (EU-direktiv 2002/96/EF) skal europæiske brugere af elektriske apparater nu returnere gamle eller udtjente apparater til producenten med henblik på bortskaffelse uden omkostninger for brugeren.</p> <p><b>Bemærk:</b> I forbindelse med returnering til genbrug skal du kontakte producenten eller leverandøren af apparatet for at få instruktioner om, hvordan udtjente apparater bortskaffes korrekt.</p> <p><b>Vigtigt dokument. Opbevares sammen med produkt dokumenterne.</b></p>	

#### SWEDISH

Elektronikutrustning som är märkt med denna symbol kanske inte kan lämnas in på europeiska offentliga sopstationer efter 2005-08-12. Enligt europeiska lokala och nationella föreskrifter (EU-direktiv 2002/96/EC) måste användare av elektronikutrustning i Europa nu återlämna gammal eller uttrangerad utrustning till tillverkaren för kassering utan kostnad för användaren.

**Obs!** Om du ska återlämna utrustning för återvinning ska du kontakta tillverkaren av utrustningen eller återförsäljaren för att få anvisningar om hur du återlämnar kasserad utrustning för att den ska bortskaffas på rätt sätt.

**Viktigt dokument. Spara tillsammans med dina produktbeskrivningar.**

#### SPANISH

A partir del 12 de agosto de 2005, los equipos eléctricos que lleven este símbolo no deberán ser desechados en los puntos limpios europeos. De conformidad con las normativas europeas locales y nacionales (Directiva de la UE 2002/96/EC), a partir de esa fecha, los usuarios europeos de equipos eléctricos deberán devolver los equipos usados u obsoletos al fabricante de los mismos para su reciclado, sin coste alguno para el usuario.

**Nota:** *Sírvase ponerse en contacto con el fabricante o proveedor de los equipos para solicitar instrucciones sobre cómo devolver los equipos obsoletos para su correcto reciclado.*

**Documento importante. Guardar junto con los registros de los equipos.**

#### DUTCH

Elektrische apparatuur die is voorzien van dit symbool mag na 12 augustus 2005 niet meer worden afgevoerd naar Europese openbare afvalsystemen. Conform Europese lokale en nationale wetgeving (EU-richtlijn 2002/96/EC) dienen gebruikers van elektrische apparaten voortaan hun oude of afgedankte apparatuur kosteloos voor recycling of vernietiging naar de producent terug te brengen.

**Nota:** *Als u apparatuur voor recycling terugbrengt, moet u contact opnemen met de producent of leverancier voor instructies voor het terugbrengen van de afgedankte apparatuur voor een juiste verwerking.*

**Belangrijk document. Bewaar het bij de productpapieren.**

#### POLISH

Sprzęt elektryczny oznaczony takim symbolem nie może być likwidowany w europejskich systemach utylizacji po dniu 12 sierpnia 2005. Zgodnie z europejskimi, lokalnymi i państwowymi przepisami prawa (Dyrektywa Unii Europejskiej 2002/96/EC), użytkownicy sprzętu elektrycznego w Europie muszą obecnie przekazywać Producentowi stary sprzęt lub sprzęt po okresie użytkowania do bezpłatnej utylizacji.

**Uwaga:** *Aby przekazać sprzęt do recyklingu, należy zwrócić się do producenta lub dostawcy sprzętu w celu uzyskania instrukcji dotyczących procedur przekazywania do utylizacji sprzętu po okresie użytkowania.*

**Ważny dokument. Zachować z dokumentacją produktu.**

#### PORTUGUESE

Qualquer equipamento eléctrico que ostente este símbolo não poderá ser eliminado através dos sistemas públicos europeus de tratamento de resíduos sólidos a partir de 12 de Agosto de 2005. De acordo com as normas locais e europeias (Directiva Europeia 2002/96/EC), os utilizadores europeus de equipamentos eléctricos deverão agora devolver os seus equipamentos velhos ou em fim de vida ao produtor para o respectivo tratamento sem quaisquer custos para o utilizador.

**Nota:** *No que toca à devolução para reciclagem, por favor, contacte o produtor ou fornecedor do equipamento para instruções de devolução de equipamento em fim de vida para a sua correcta eliminação.*

**Documento importante. Mantenha junto dos registos do produto.**